

# Solar Dock Dots – (1-3/8")

MODEL: LL-SDD-DOT

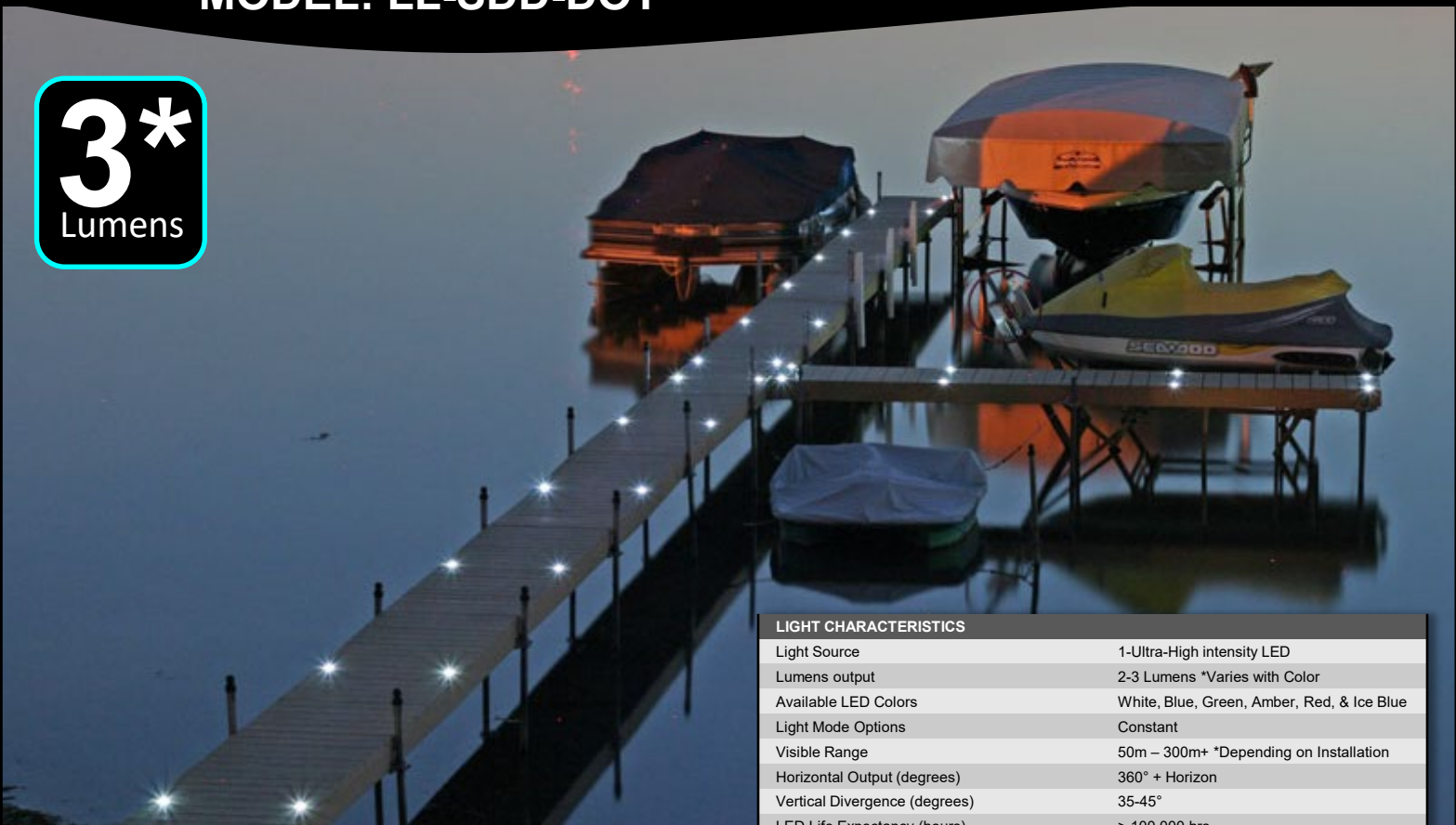

**3\***  
Lumens



## Solar Dock Dots: LL-SDD-DOT

Solar Dock Dots are simply the neatest, smallest, solar lights you have ever seen! Super Bright LEDs make these brilliant solar lights stand out at night! A flush mount makes them virtually unnoticeable during the day and eliminates any tripping hazards. Easy to install in minutes with a quick 1-3/8" drill bit or hole saw. A super bright LED and powerful solar panel provide all night illumination. Impress all the neighbors with these simply to install solar units!

6-Color Options to choose from: White, Blue, Green, Red, Amber, & Ice Blue

### LIGHT CHARACTERISTICS

Light Source	1-Ultra-High intensity LED
Lumens output	2-3 Lumens *Varies with Color
Available LED Colors	White, Blue, Green, Amber, Red, & Ice Blue
Light Mode Options	Constant
Visible Range	50m – 300m+ *Depending on Installation
Horizontal Output (degrees)	360° + Horizon
Vertical Divergence (degrees)	35-45°
LED Life Expectancy (hours)	> 100,000 hrs

### ELECTRICAL CHARACTERISTICS

Circuit Protection	Integrated
Nominal Voltage (v)	1.2v
Autonomy (hours)	16-20hrs *On full Charge
Temperature Range	-4 to 158° Fahrenheit

### SOLAR CHARACTERISTICS

Solar Module Type	Multicrystalline or Monocrystalline
Power (watts)	0.45 watts
Solar Module Efficiency (%)	16-17%

### POWER SUPPLY

Battery Type	High Grade NiMH – ECO Friendly
Battery Size	1/3 AAA
Battery Capacity (mAh)	120 mAh
Nominal Voltage (v)	1.2v
Battery Service Life	1-3 years (Varies with local Environment)
Battery Service Access	Yes: User Changeable / Replaceable

### PHYSICAL CHARACTERISTICS

Body Material	UV Stabilized Poly Carbonate
Lens Material	UV Stabilized Poly Carbonate
External Lens Design	Integrate Convex Optics & Diffusion
Internal Lens design	360° Convex Optics & Diffusion
Waterproof Rating	IP 68
Mounting	1 – hole (1-3/8") Diameter / (35mm)
Height	1-3/8"
Width / Diameter	1-3/8" Body & 1.70" Lip
Weight	.6 Lbs (4 pack)

### OPTIONS

Custom Options, Sizes, & Colors	Please Contact
Custom Hardware & Mounting	Please Contact

\* Information subject to change without notice



Lake Lite Inc.  
100 Industrial Dr.  
Avilla, IN 46710

Phone: 260-918-2758  
E-mail: sales@lakelite.com  
Web: www.lakelite.com

# Solar Dock Dots – (1-3/8")

MODEL: LL-SDD-DOT



Dimensions = mm

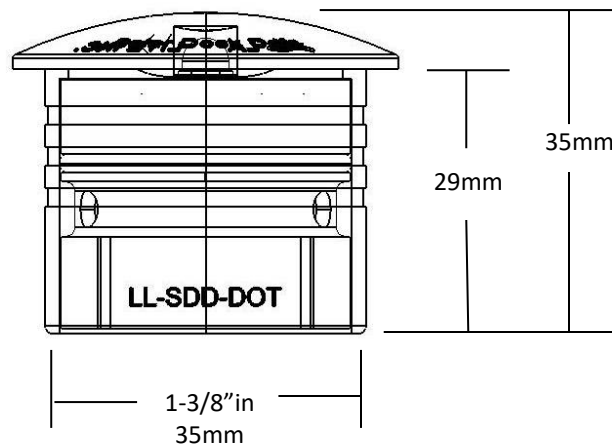
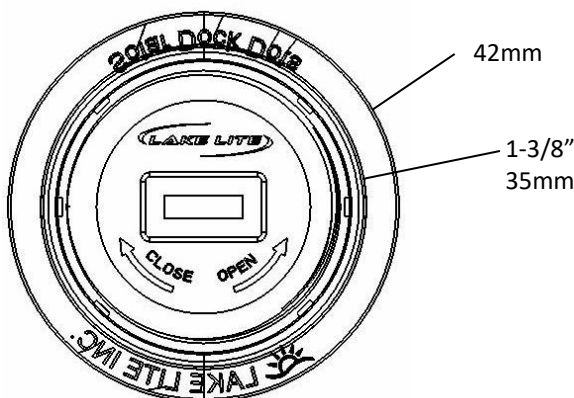
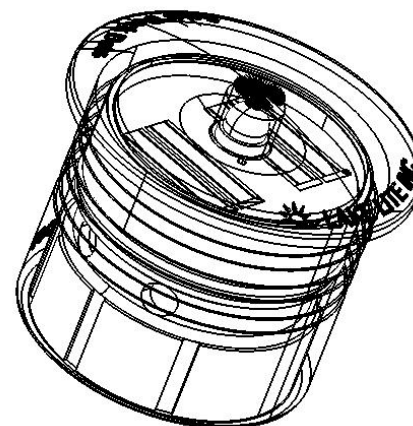
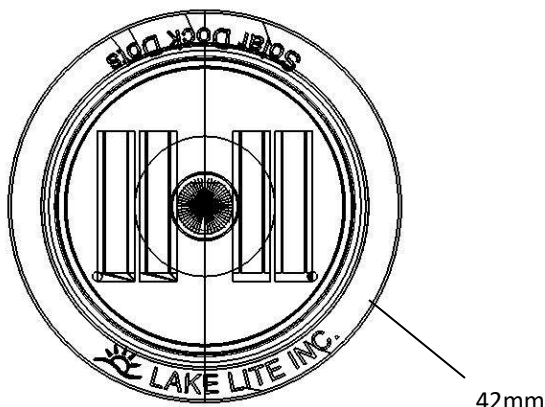

## Owner Registration Card

Please fill out and affix proper postage and return this owner registration card **within 10 days** to ensure that your new Solar Dock Dots is covered by the limited warranty.

Purchaser's Name \_\_\_\_\_

Address \_\_\_\_\_

State \_\_\_\_\_ Zip \_\_\_\_\_

Purchase Date: \_\_\_\_\_ Number of Lights: \_\_\_\_\_

Where Purchased (Store Name): \_\_\_\_\_

Model No. LL-SDD-DOT

UPC No. Varies On Different Models

Lake Lite Inc.  
100 Industrial Dr., Avilla, IN 46710

## Lake Lite Inc. 1-Year Limited Warranty

The retailer warrants the Solar lights to be free from defects in workmanship and material present at time of shipment from the factory for a period of one year after the date of purchase by the original purchaser. We agree to correct such defects without charge or at our option replace with a comparable or superior model if the product is returned to the retailer. To obtain warranty service, you must present a copy of the receipt as proof of purchase. All costs of removing and reinstalling the product are your responsibility. Damage to any part such as by accident or misuse or improper installation or by affixing any accessories, is not covered by this warranty. There is no other express warranty. The retailer hereby disclaims all warranties, including but not limited to, those of merchantability and fitness for a particular purpose to the extent permitted by law. The duration of any implied warranty, which cannot be disclaimed, is limited to the time period as specified in the express warranty. Some states do not allow limitation on how long an implied warranty lasts, so the above limitation may not apply to you. The retailer shall not be liable for incidental, consequential, or special damages arising out of or in connection with product use or performance except as may otherwise be accorded by law. Some states do not allow the exclusion of incidental or consequential damage, so the above exclusion or limitation may apply to you. This warranty gives specific legal rights, and you may also have other rights, which vary from state to state. This warranty supersedes all prior warranties.



Lake Lite Inc.  
100 Industrial Dr.  
Avilla, IN 46710

Phone: 260-918-2758  
E-mail: sales@lakelite.com  
Web: www.lakelite.com

# Solar Dock Dots – (1-3/8")

MODEL: LL-SDD-DOT



## Installing Batteries

1. Remove Back Cover with Screwdriver
2. Remove Plastic Isolation Tab
3. Install Battery in correct position
4. Install Silicon Pad over battery
5. Install plastic cover with screwdriver
6. Turn Tightly to make a good seal

(Replace with 1.2v NiCd or NiMh type Rechargeable Batteries ONLY)

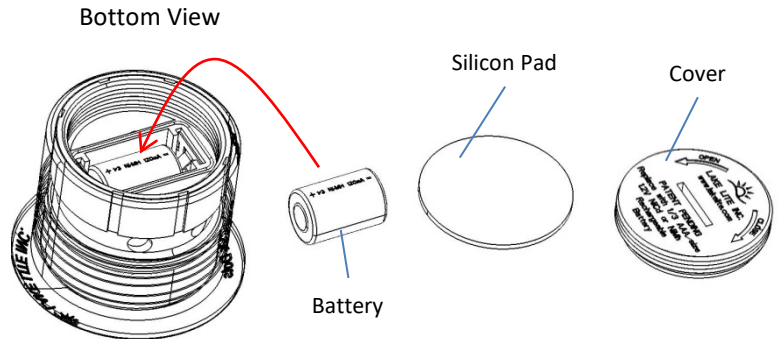

## Mounting to Surface

1. Mark Desired locations for mounting solar lights
2. Use 1-3/8" (35mm) diameter saw to make hole
3. Install lights into hole
4. If necessary, you may use a silicone-based glue to secure light into place

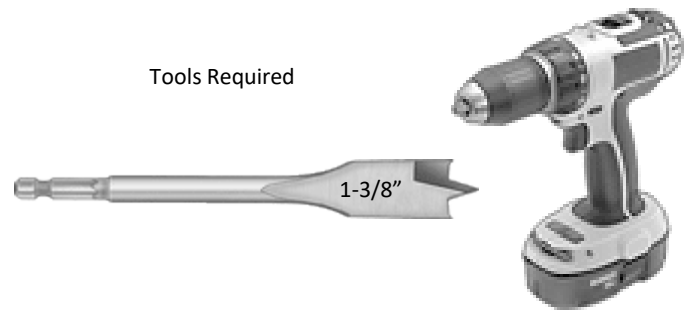

Tools Required

## Storage Tips (Harsh Winters)



### Extreme winter weather can reduce the life expectancy of your Solar Dock Dot

1. Extreme Cold weather can dramatically reduce the life expectancy of your rechargeable Ni-Cd or Ni-Mh battery.
2. Store your Solar Dock Dot Lite inside during cold months when your dock is not in use.



CAUTION: CONTAINS NICKEL-CADMIUM BATTERIES. BATTERY MUST BE RECYCLED OR DISPOSED OF PROPERLY.



Lake Lite Inc.  
100 Industrial Dr.  
Avilla, IN 46710

Phone: 260-918-2758  
E-mail: sales@lakelite.com  
Web: www.lakelite.com